

1 A

1 A



1 B

1 B

1 B

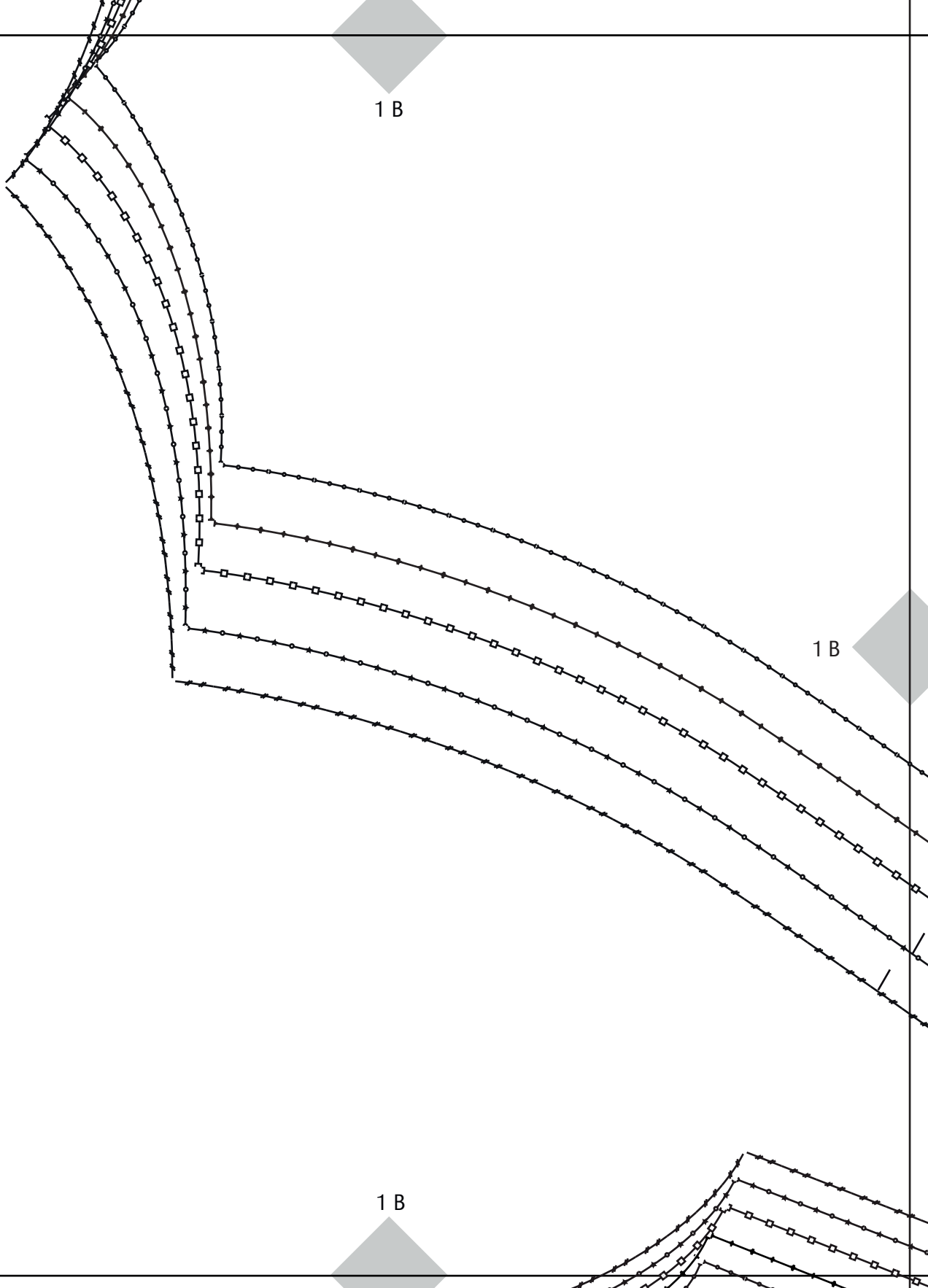

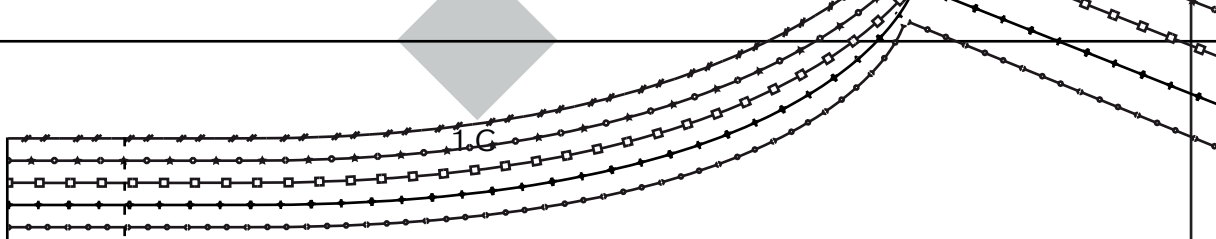

MAKE MY LEMONADE

ROBE LUISA

DF

EMPIECEMENT DOS X4

PIECE 1/6

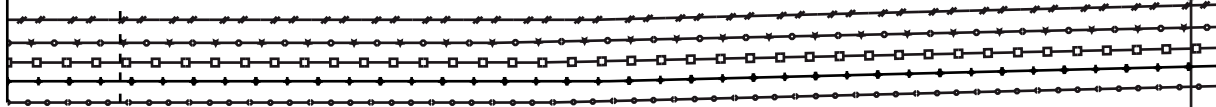

1 C

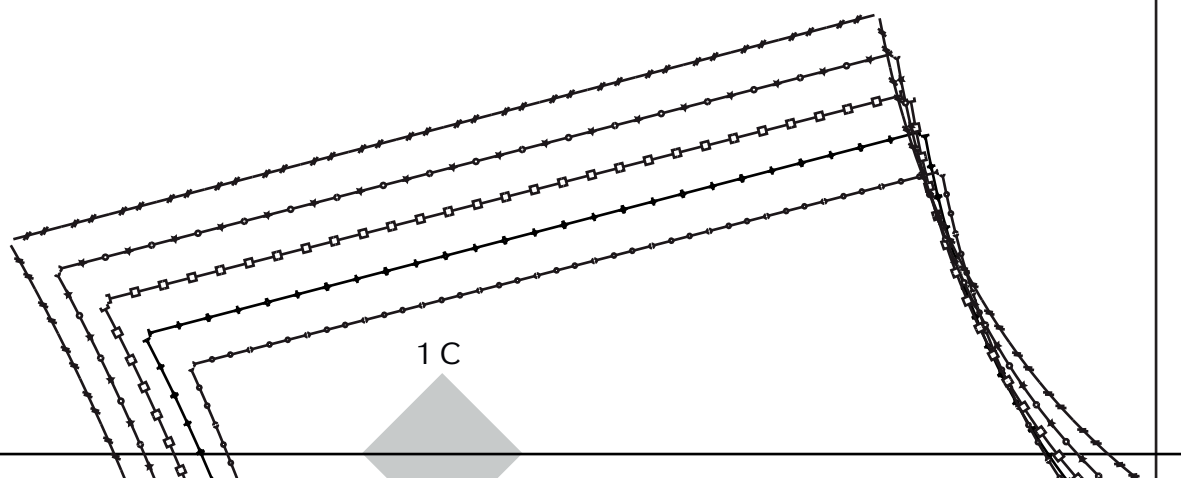

1 C

1 D

1 D

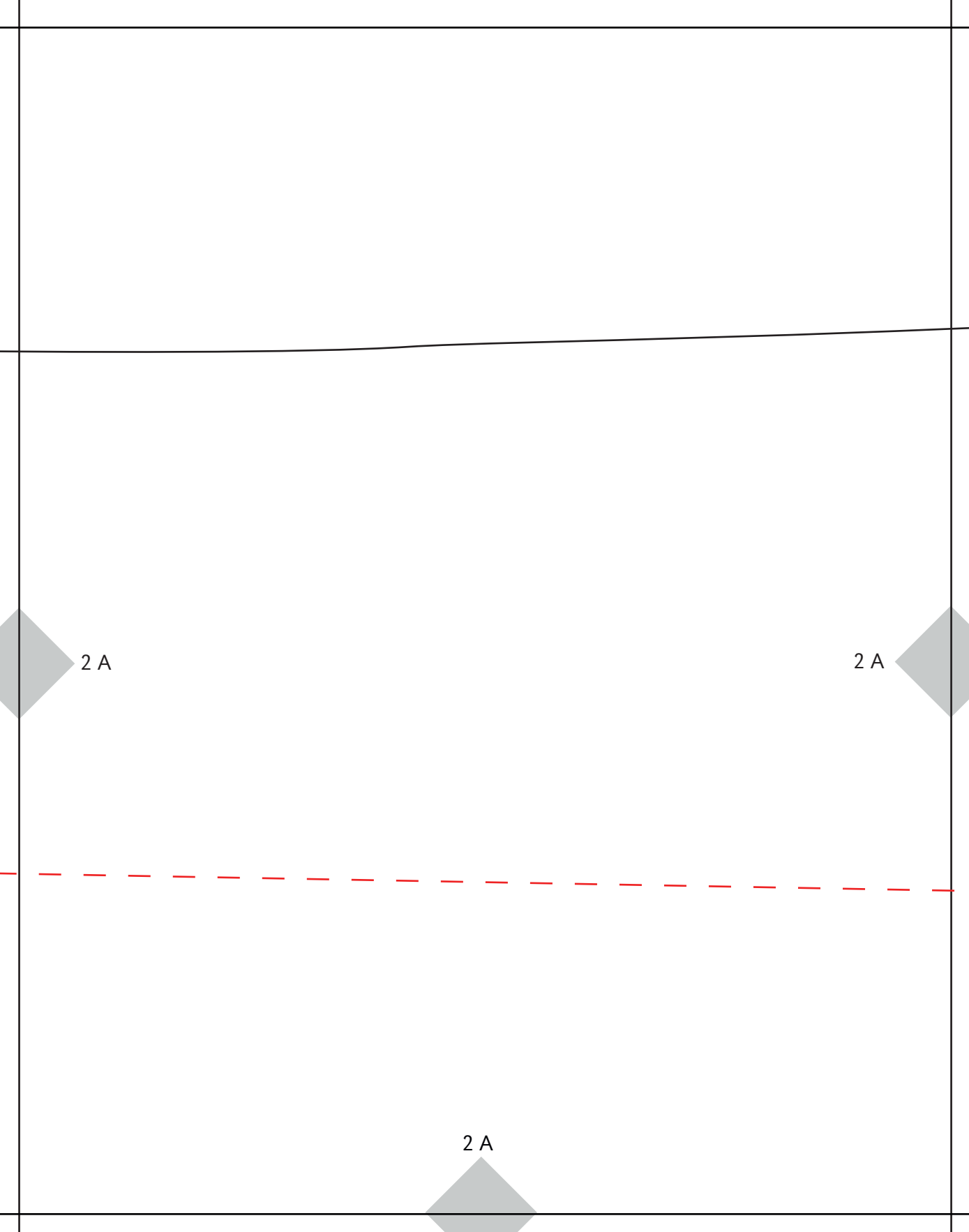

2 A

2 A

2 A

2 B

MAKE MY LEMONADE

ROBE LUISA

2 B

2 B

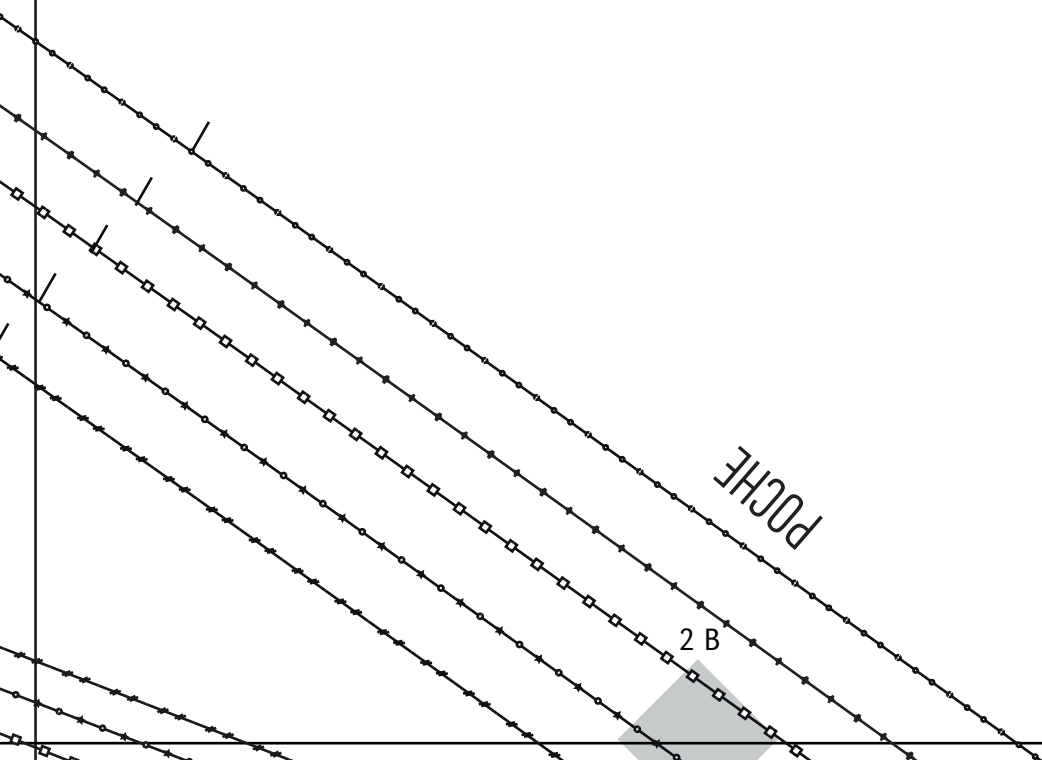

2 B

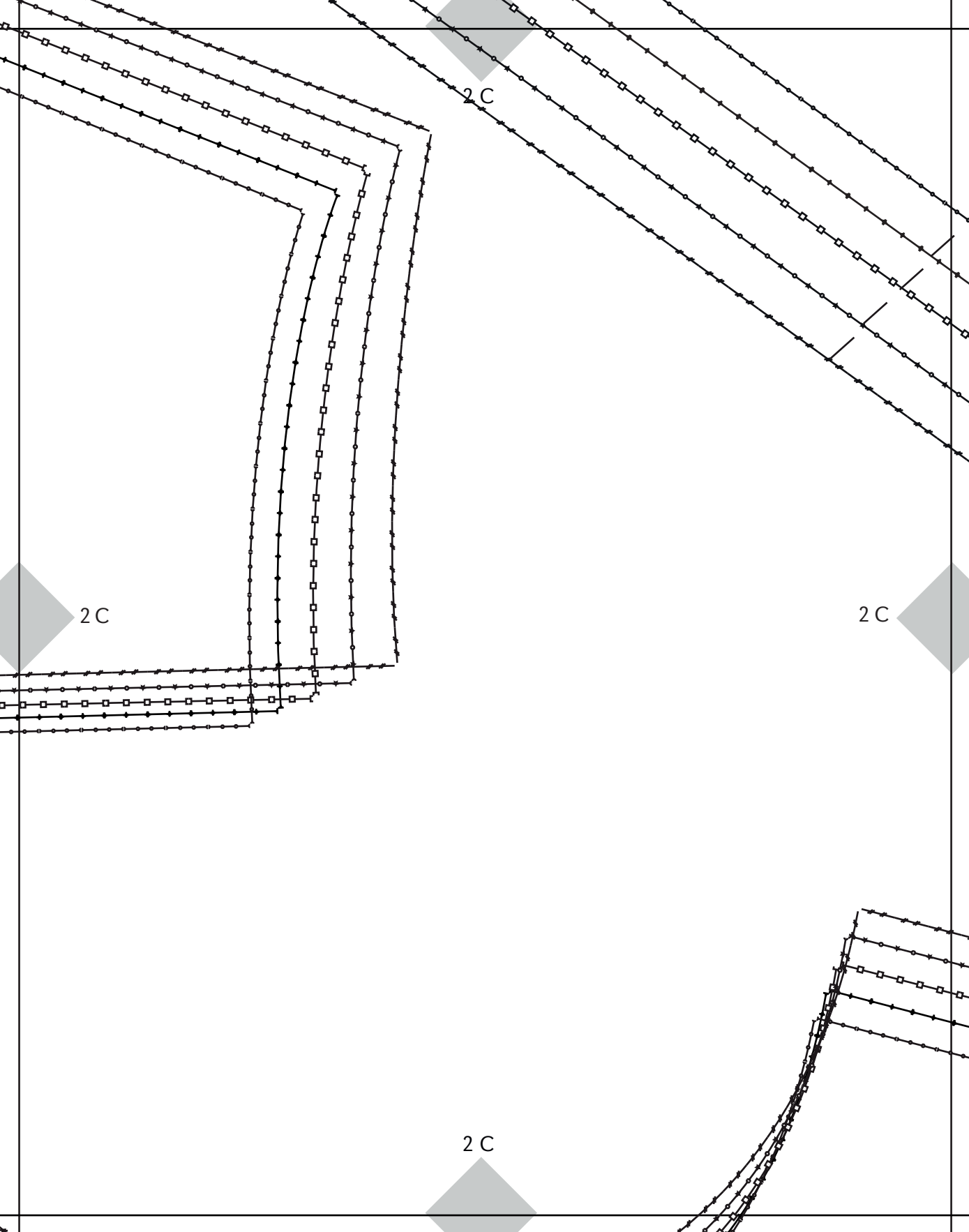

2 D

MAKE MY LEMONADE

ROBE LUISA

EMPIECEMENT DEVANT X2

2 D

PIECE 2/6

DF

2 D

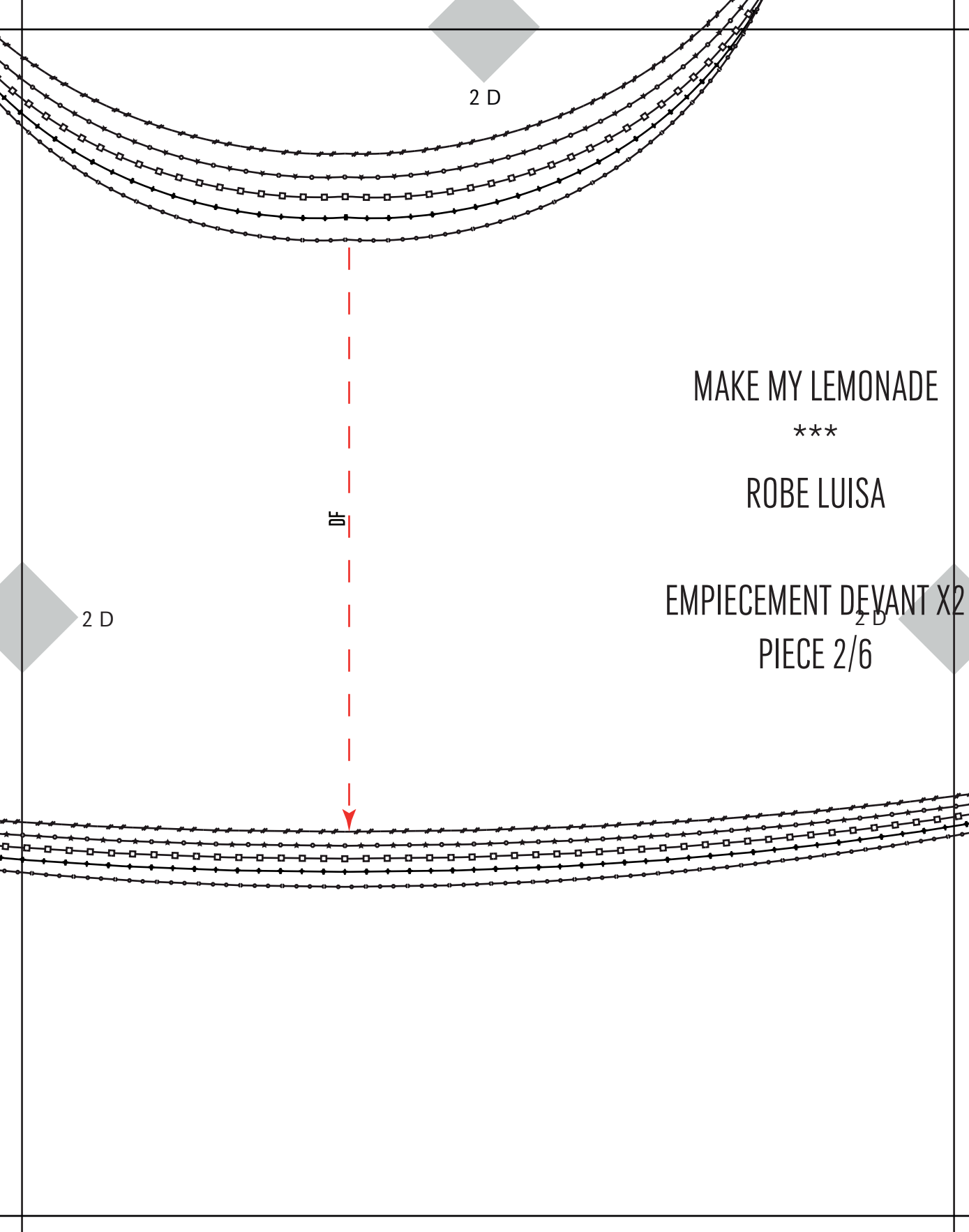

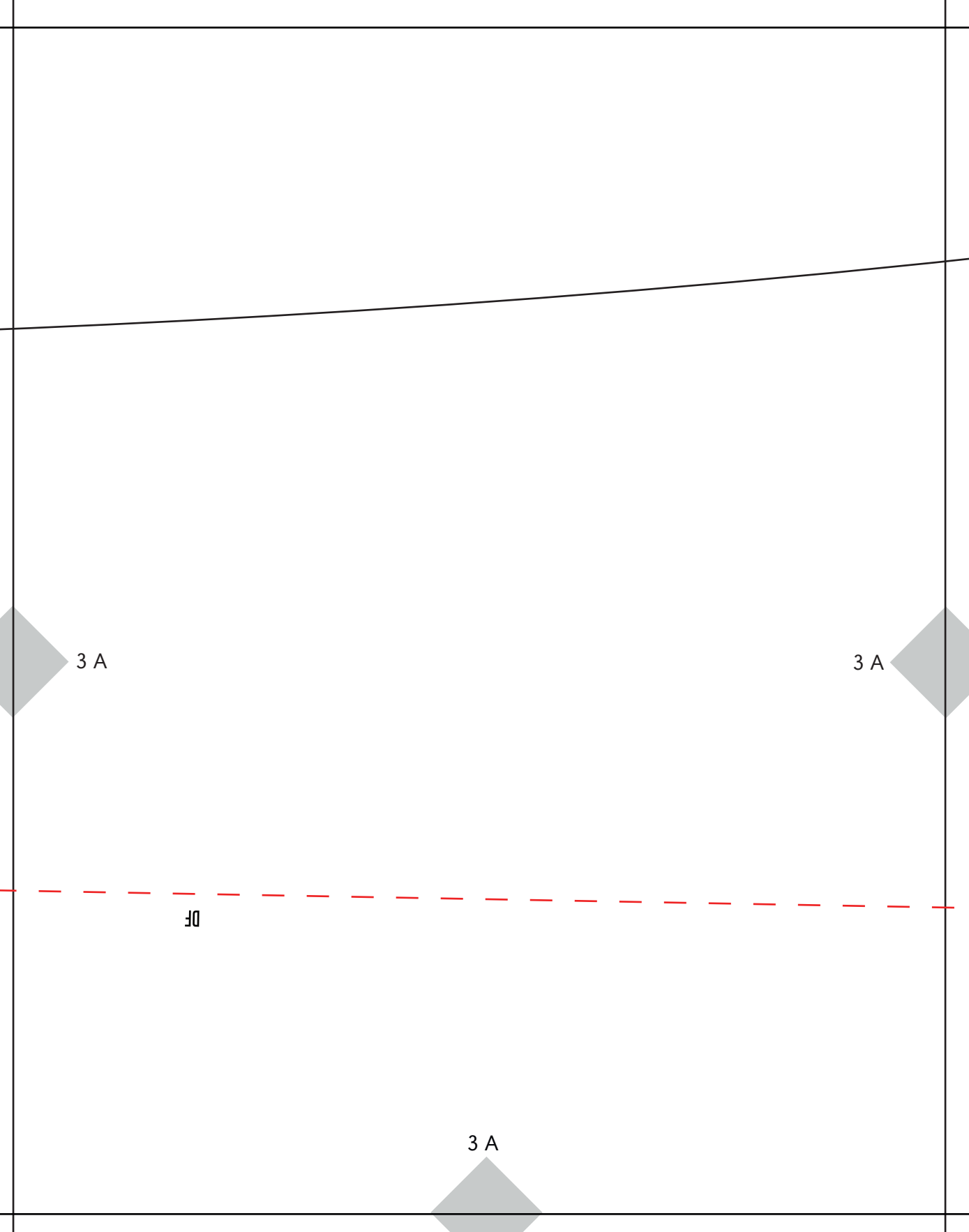

3 A

3 A

3 A

DE

JUPE DEVANT AU PLI

PIECE 3/6

3 B

3 B

3 B

3 B

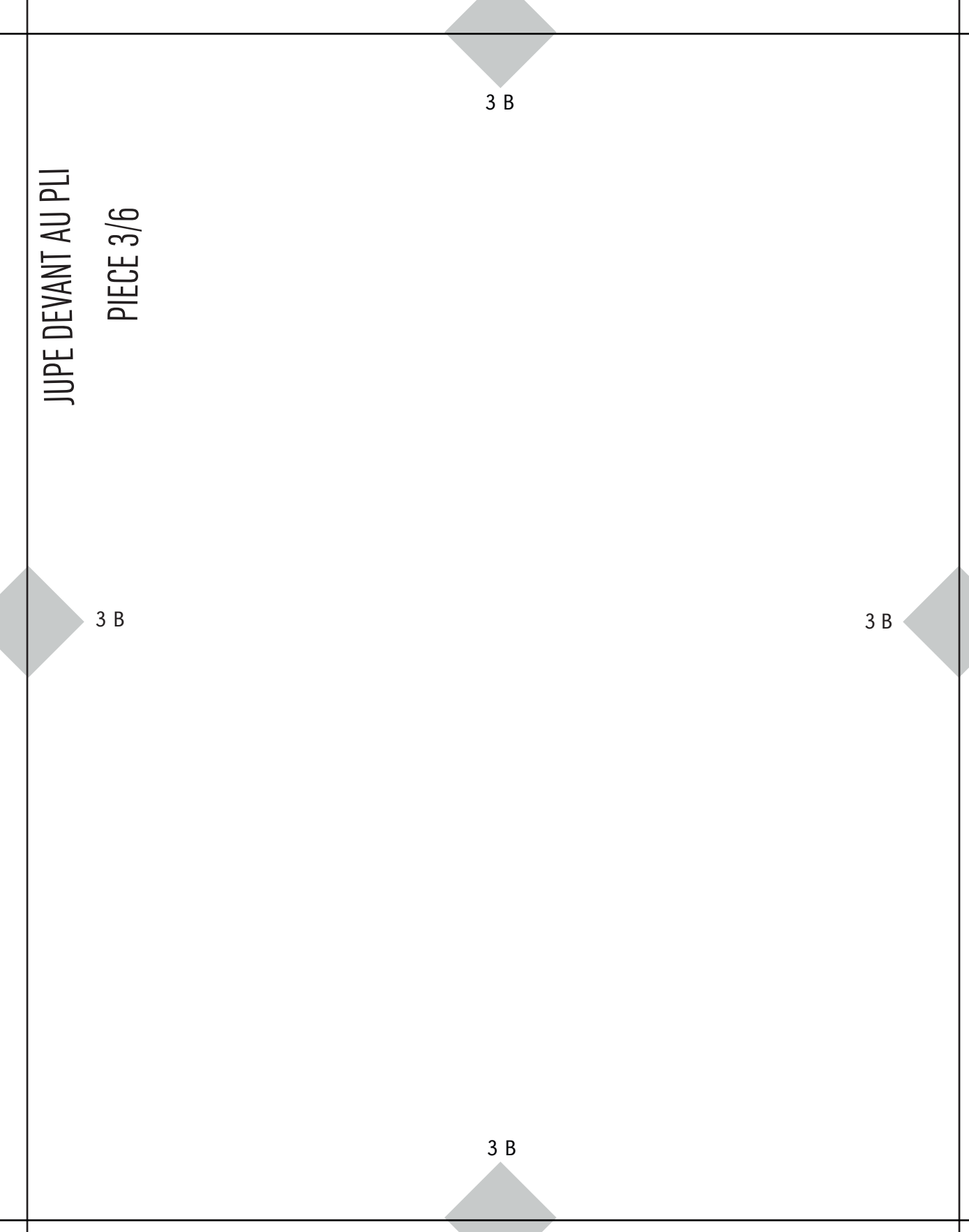

3 C

3 C

3 C

3 C

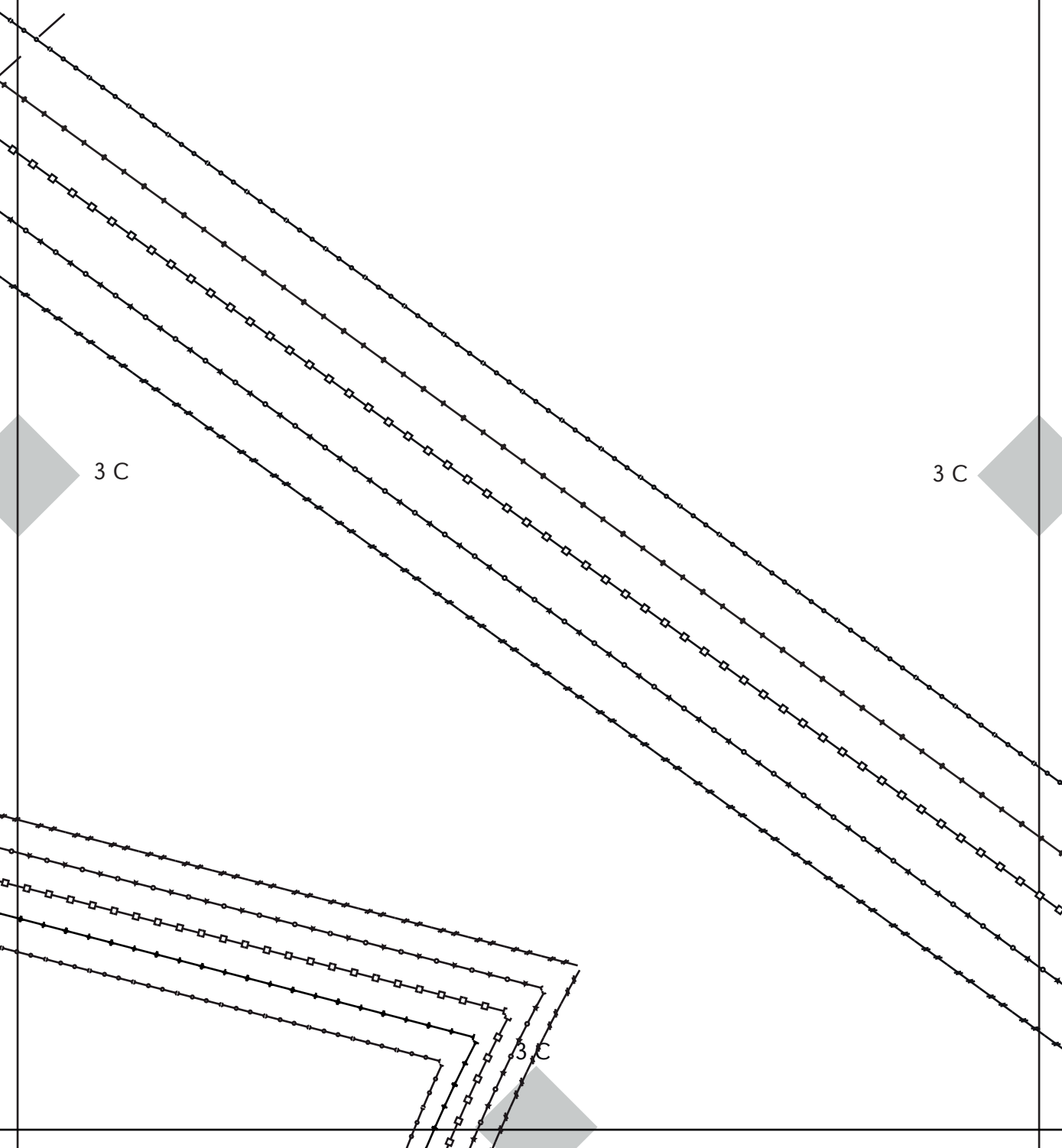

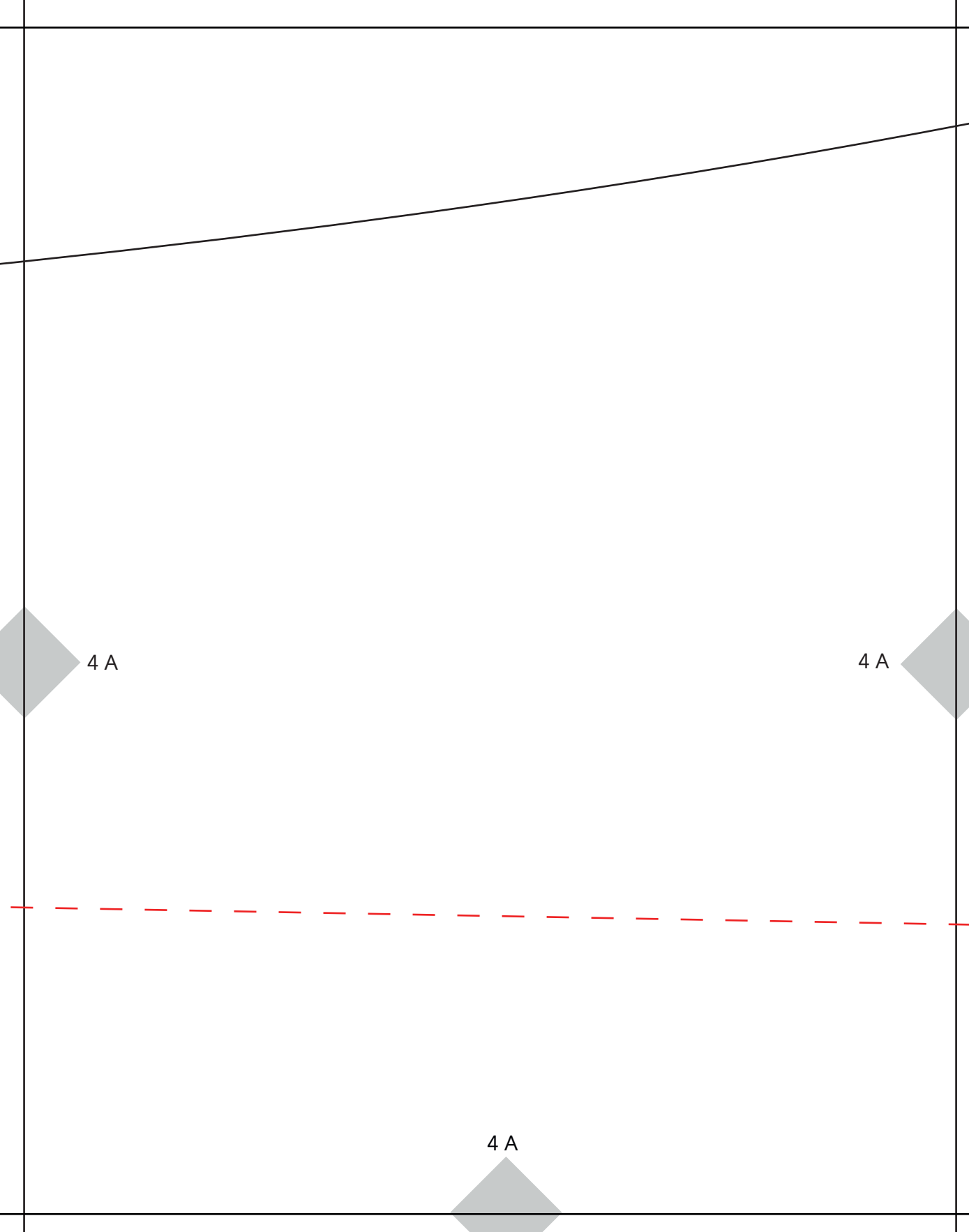

4 A

4 A

4 A



4 B

4 B

4 B

4 B

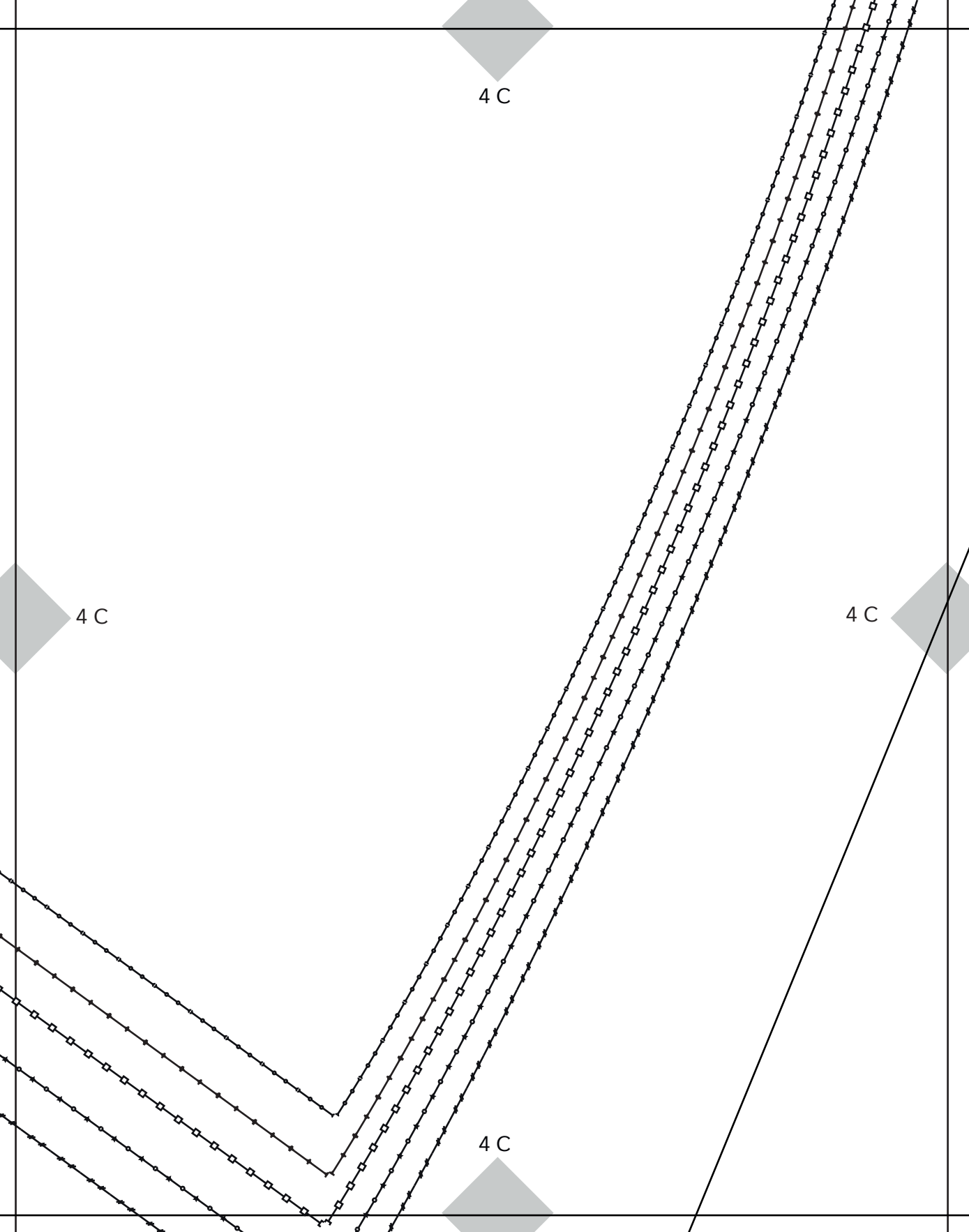

4 C

4 C

4 C

4 C

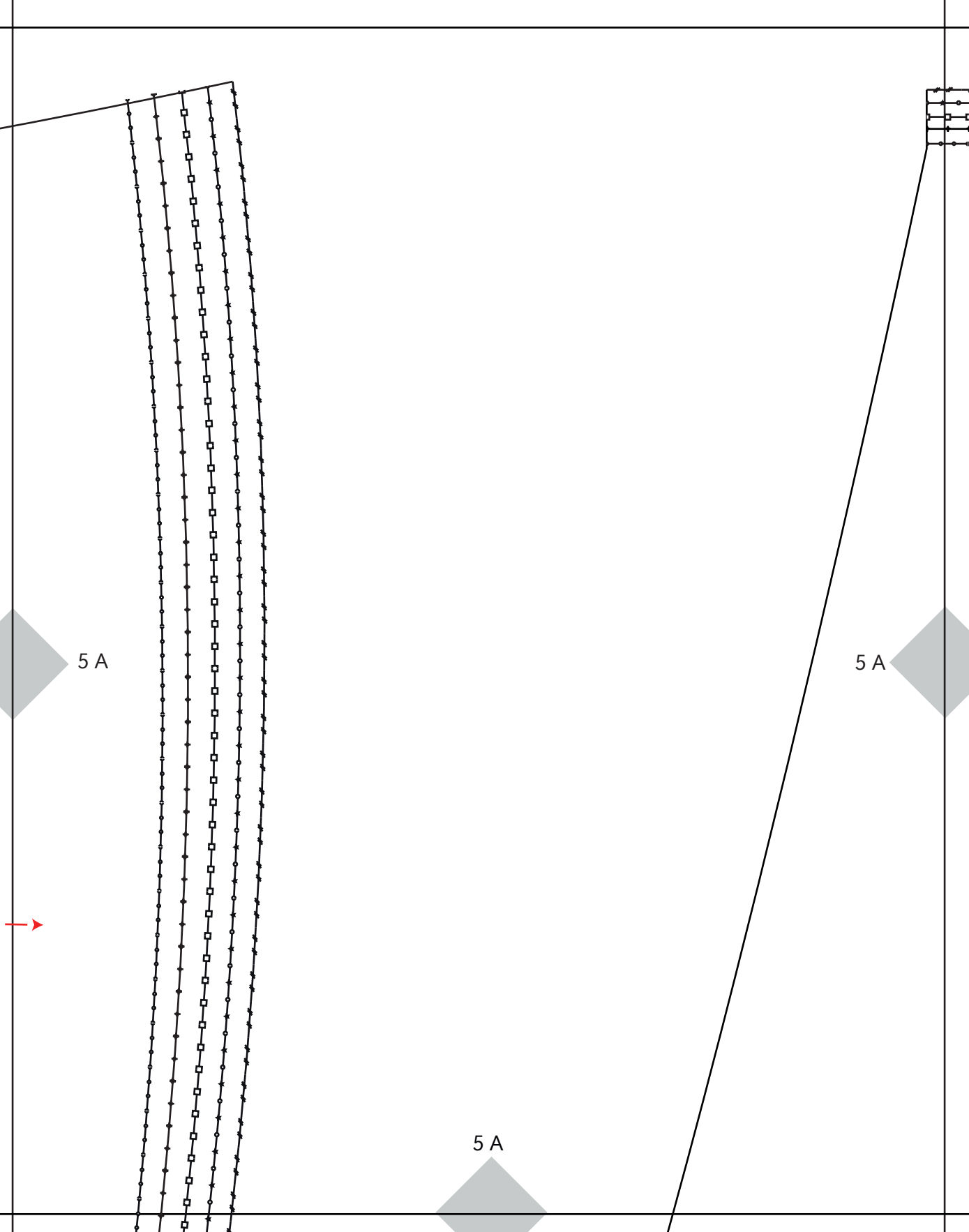

5 A

5 A

5 A

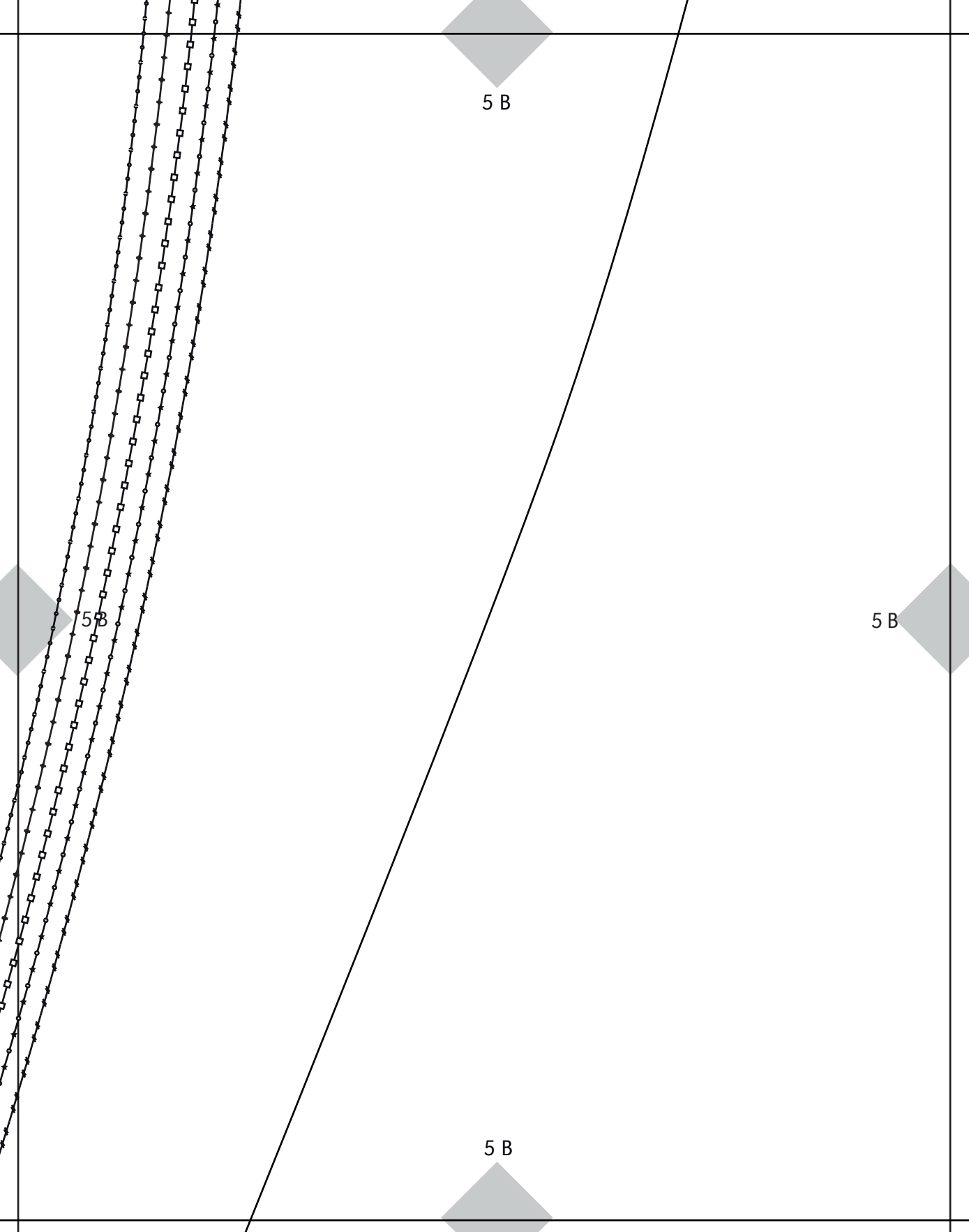

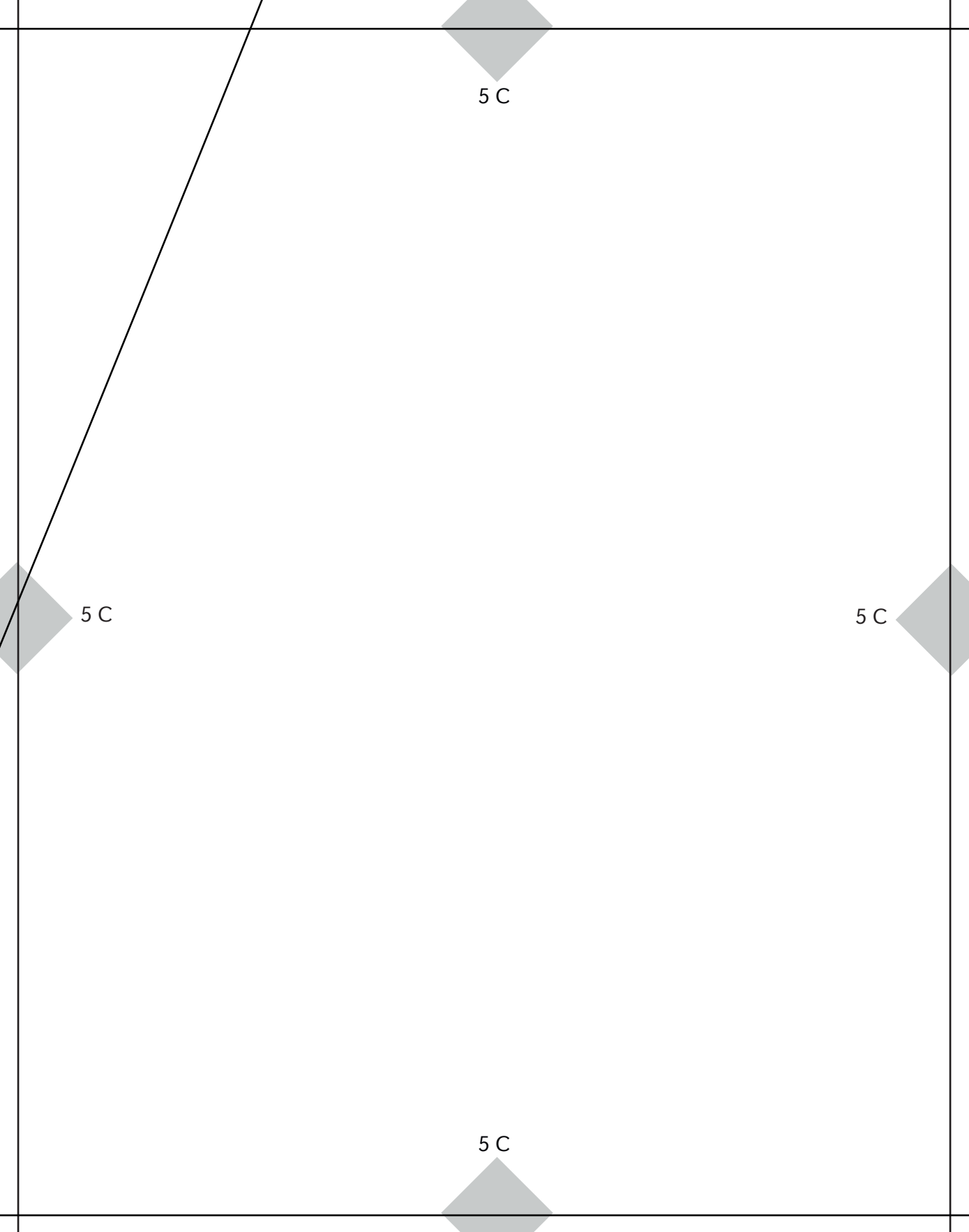

5 C

5 C

5 C

5 C

5 D

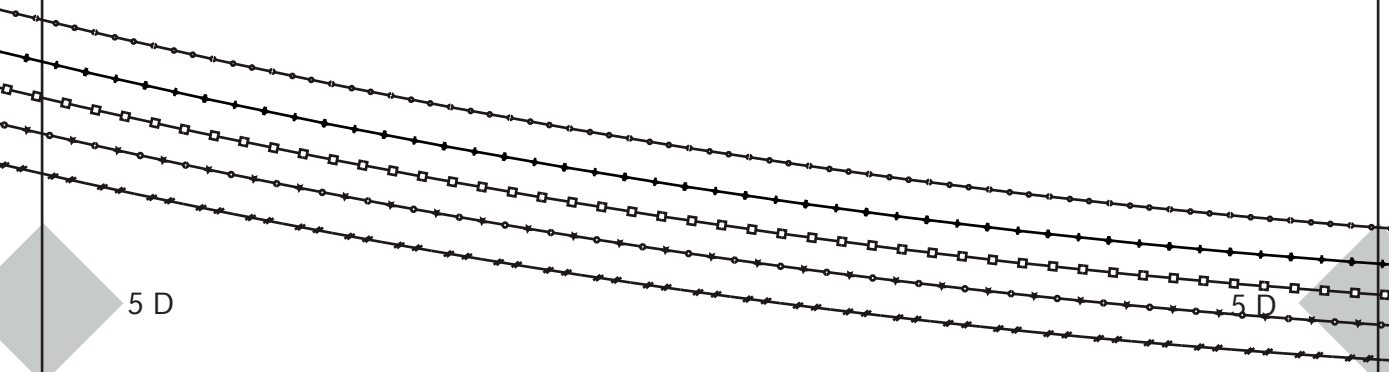

5 D

5 D

ont des marques déposées. Tou

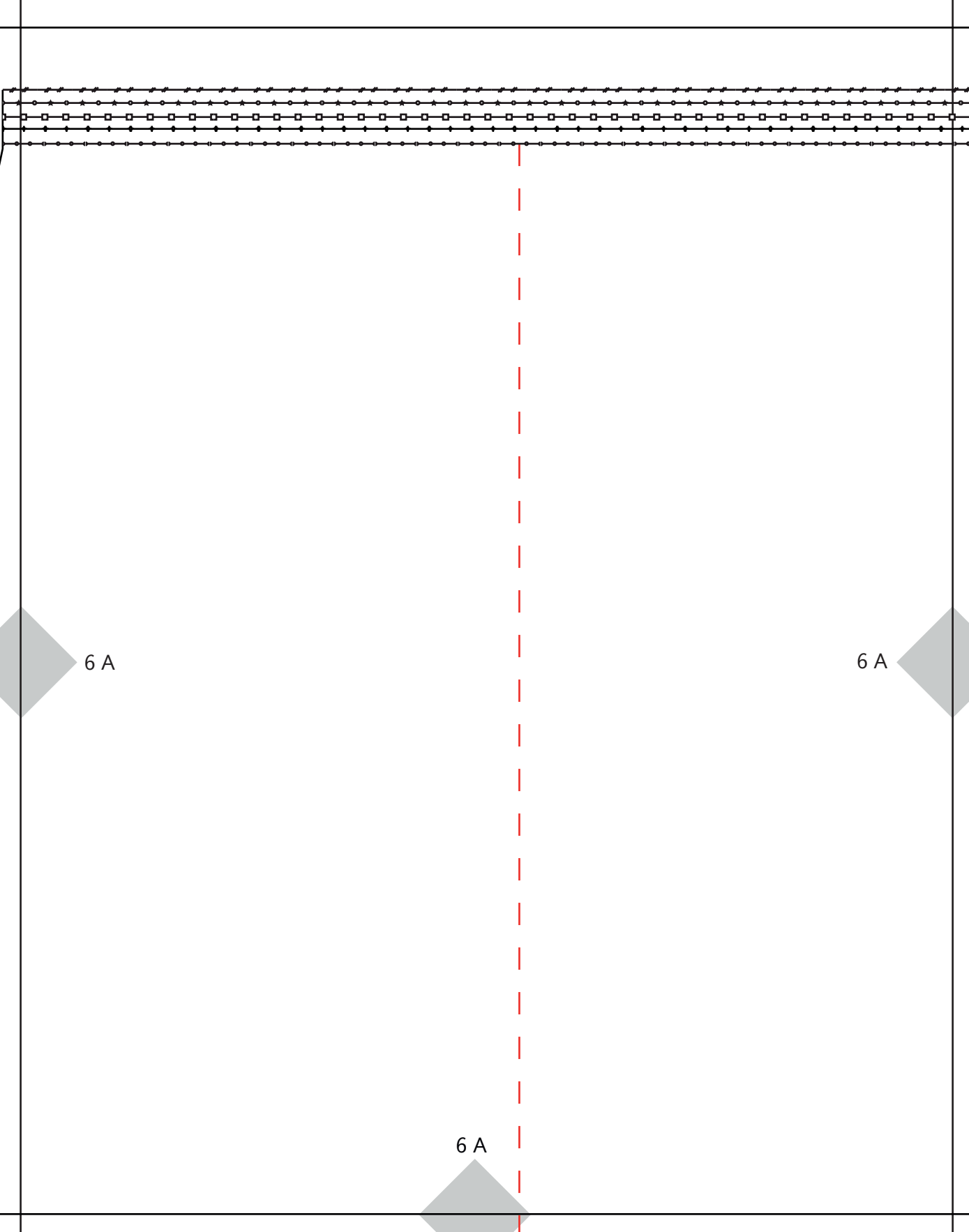

6 A

6 A

6 A

6 B

6 B

6 B

6 B $\frac{1}{2}$

M

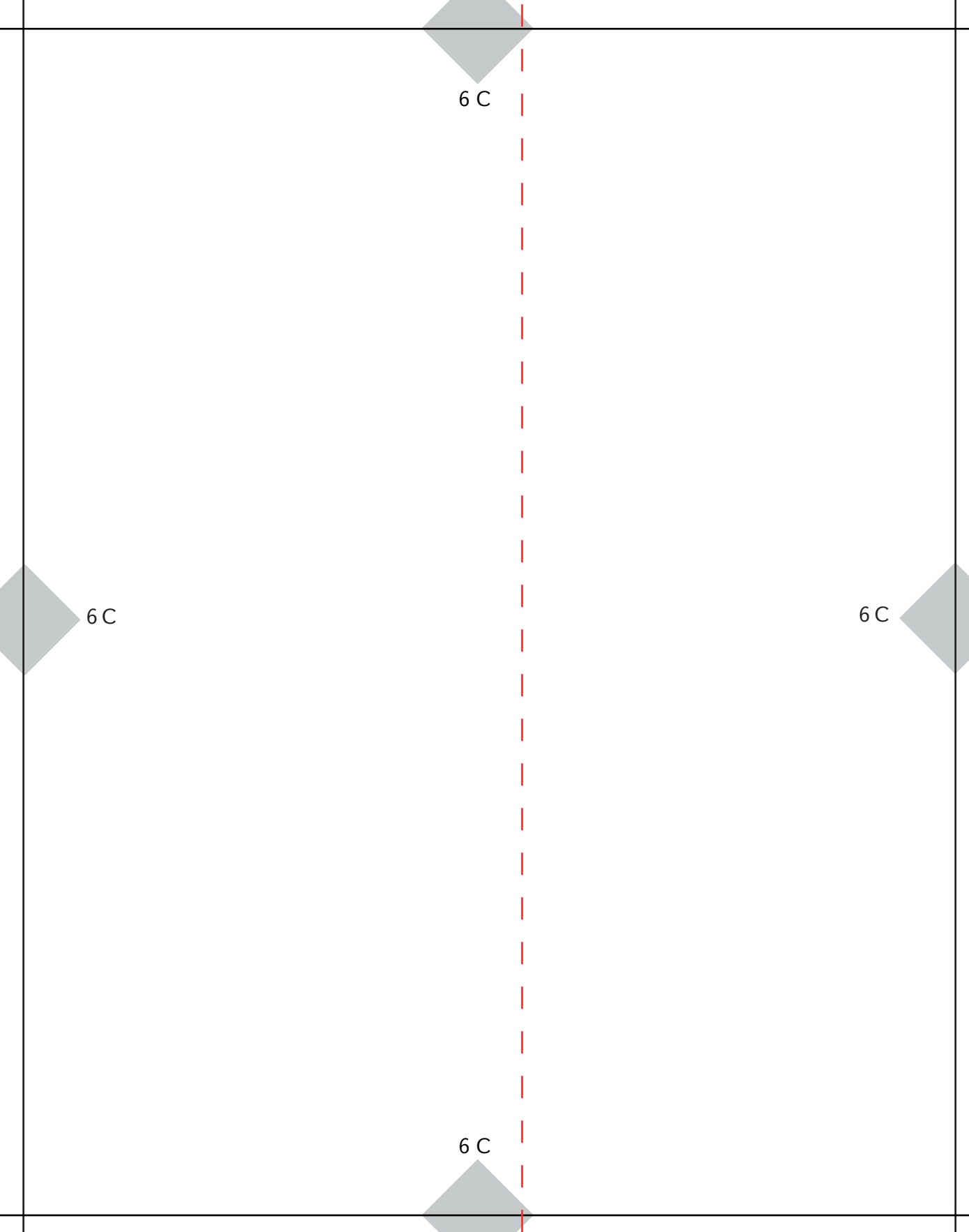

6 C

6 C

6 C

6 C



6 D

6 D

6 D

us droits réservés Copyright ©

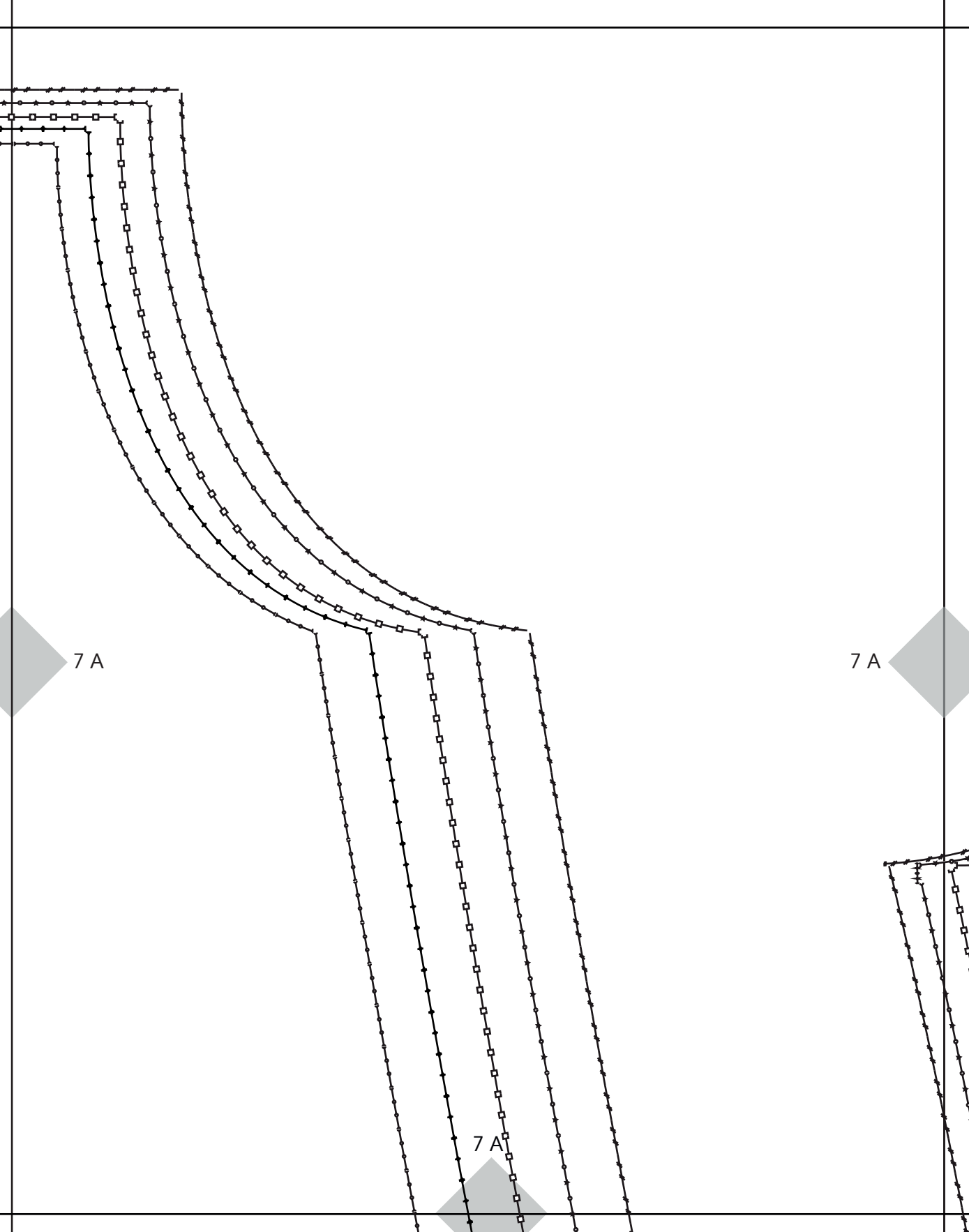

7 A

7 A

7 A

7 B

7 B

7 B

POCHE

MAKE MY LEMONADE

ROBE LUISA

7 B

HIFE DOS X2

JUPE DOS X2

PIECE 4/6

7 C

7 C

7 C

7 C

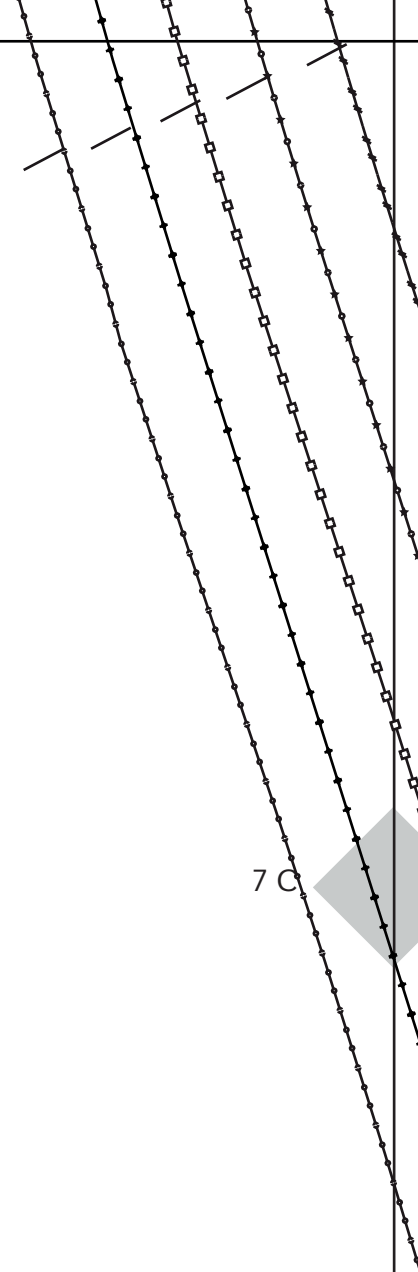

7 D

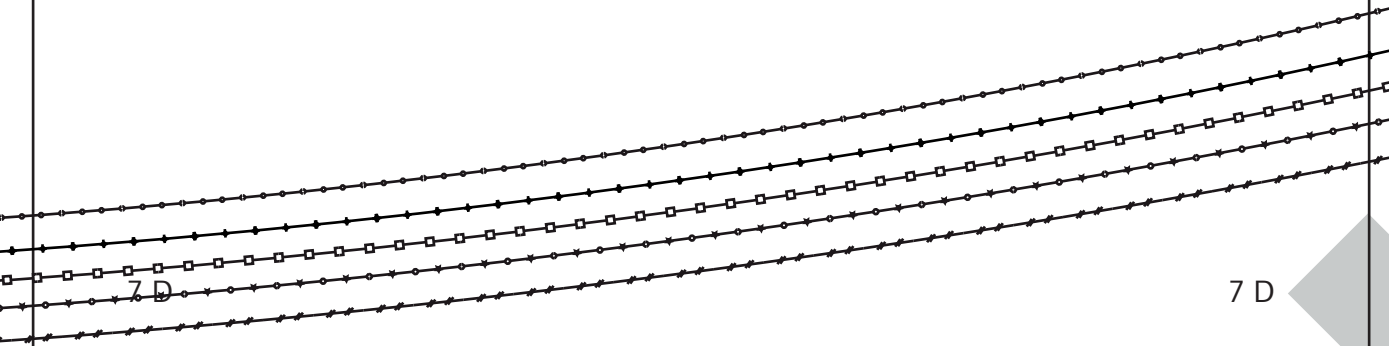

7 D

© 2013 WWW.MAKEMYEMONADE

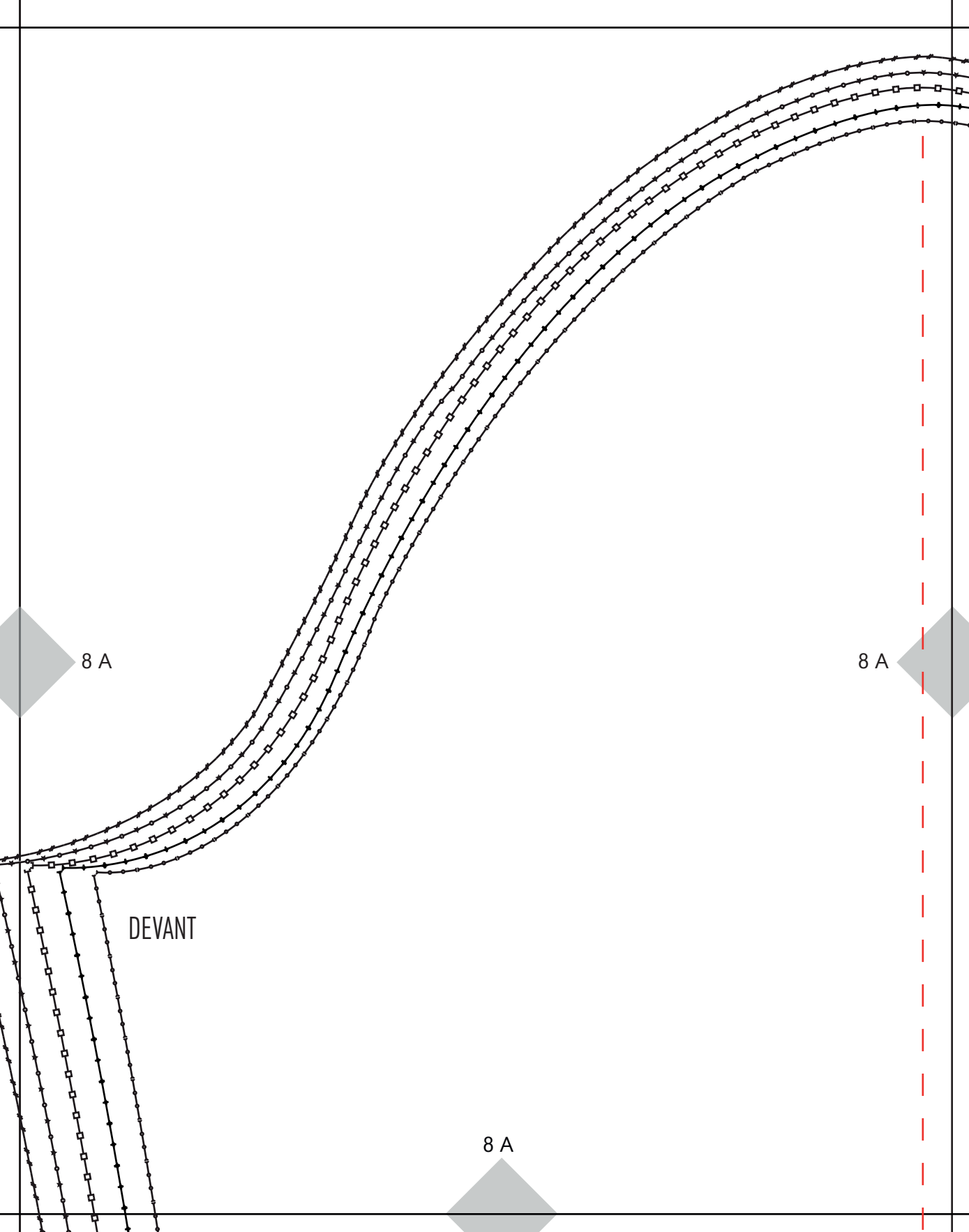

8 A

8 A

8 A

DEVANT

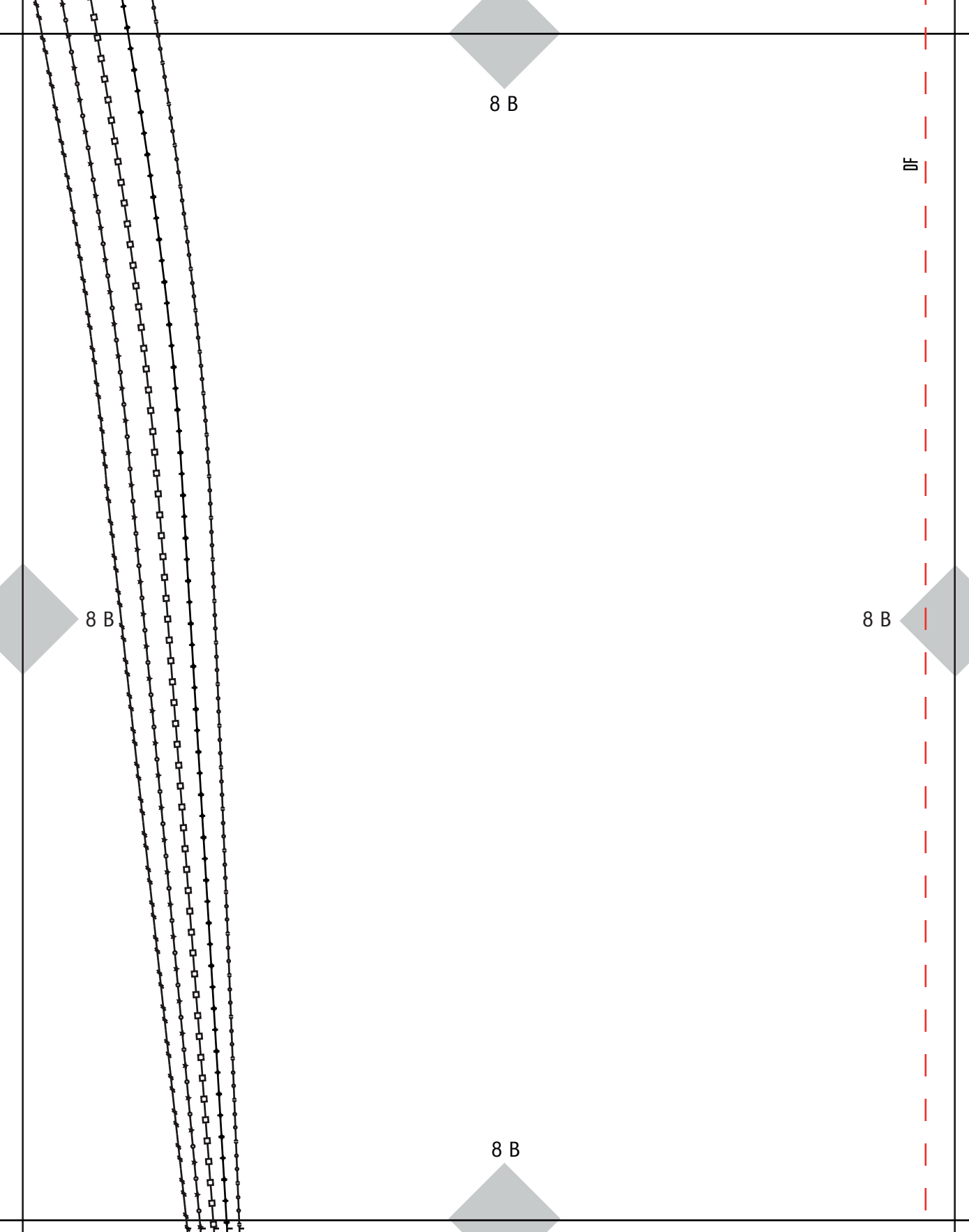

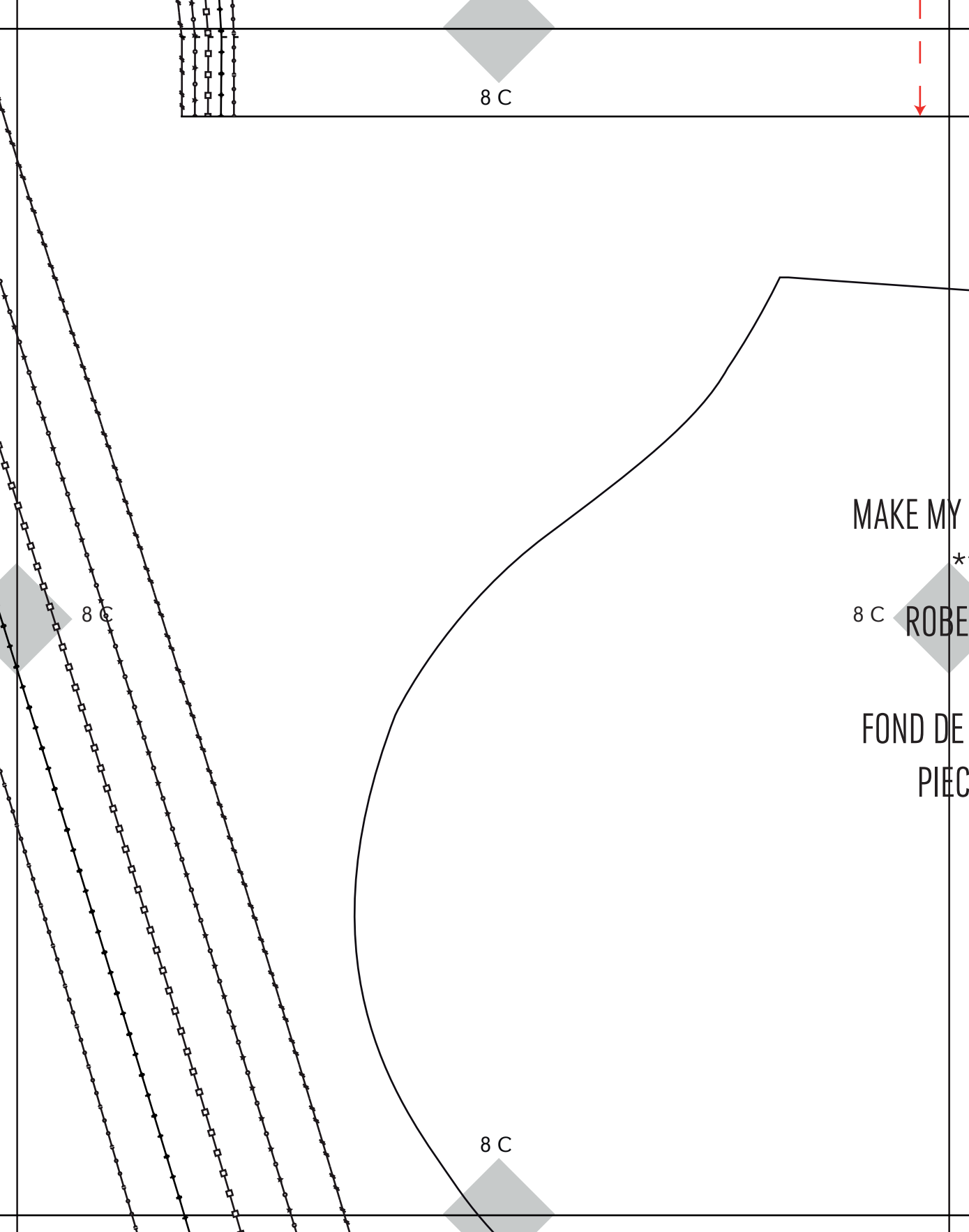

8 C

8 C

8 C

MAKE MY

*

8 C ROBE

FOND DE

PIEC

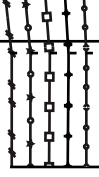

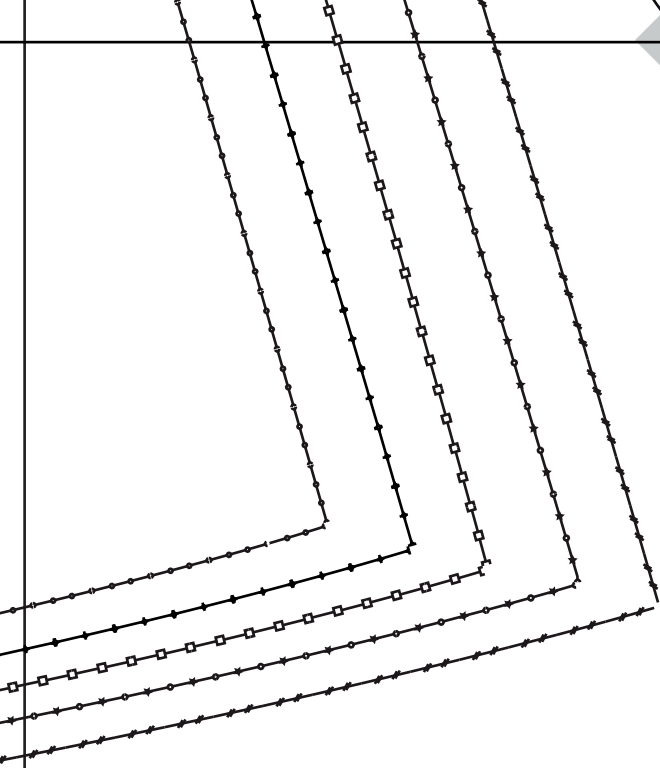

8 D

8 D

*We
Lemon*

E.COM - WEAR LEMONADE - ROBE

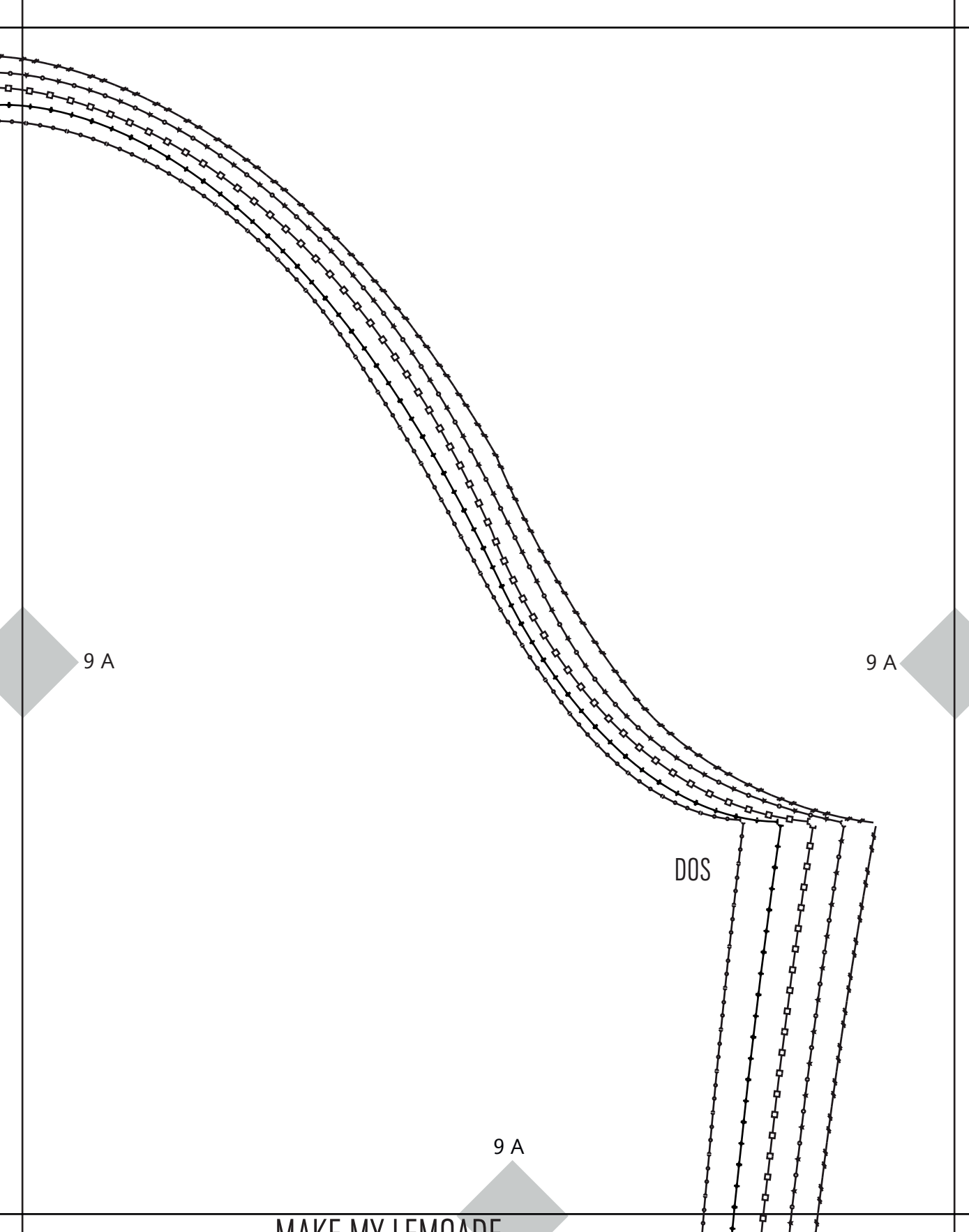

9 A

9 A

DOS

9 A

MAKE MY LEMOADE

MAKE MY LEMOADE

9 B

ROBE LUISA

MANCHE X2

PIECE 5/6

9 B

9 B

9 B

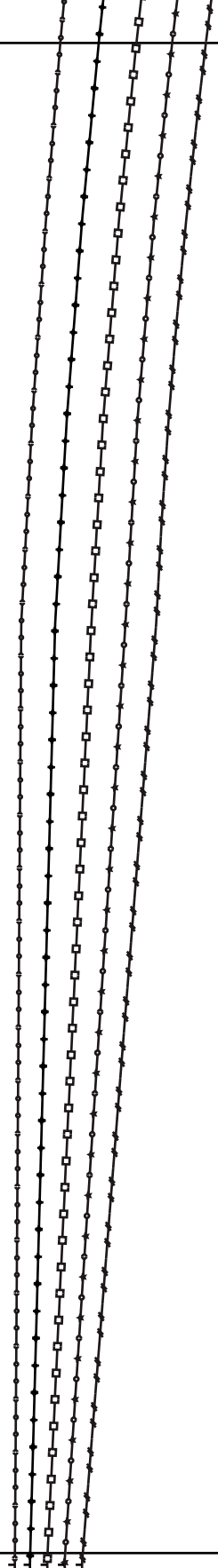

9 C

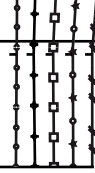

MY LEMONADE

BOBE LUISA

DE POCHE X4

PIECE 6/6

9 C

9 C

9 D

ear
made

9 D

BE LUISA